

OPERATOR'S MANUAL



T-BOX™ 2



CONTENTS

Introduction	2
Features and Functions	3
Before Use	3
Updates	3
Preparation	3
Assembly and Connections	4
Front Panel Connectors	5
Rear Panel Connectors	6
Operation	6
Power up	6
Select Task Screen	7
Select AnB Screen	8
Measure Screen	9
Mode Selection Screen	11
Progressive Reset	13
Broadcast Capture Trigger	14
Units Selection Menu	15
Readings Screen	16
File Browser	17
Targets Screen	19
Target Settings	21
Target Editor	22
Linked Targets	23
Graphing Screen	24
Axis Configurator	25
Graphing Settings Menu	26
Settings Screen	27
Units Screen	28
Serial Port	28
System Info	28
Password	28
Software Update Procedures	29
Specification – General	30
Specification – Transducer Interface	31
Smart Transducers	31
Pin Connection	31
Connector Type	31
Specification – Ancillaries	32
Pin Connections	32
External Print / Reset Input	32
Limit Outputs	32
Tool Stop Output	32
Analogue Output	33
External Snug Trigger Input	33
Connector Type	33
Specification – Serial Port	34
Pin Connections	34
Data Output Example	34
Connector type	34
Connecting Lead	34

Specification – USB	34
Maintenance	35
T-Box™ 2 Calibration	35
Transducer Calibration	35
Repair	35
Cleaning	35
Product Disposal	35
Battery Disposal	35
Troubleshooting	36
Example Setups	37
Example 1 – Click Wrench Torque Measurement	37
Example 2 – Copy Readings Folder to Memory Stick	38
Example 3 – Hydraulic Wrench calibration	39
Glossary of Terms	40

INTRODUCTION

The T-Box™ 2 is a highly accurate torque measuring instrument with an intuitive 10.1" colour touch screen interface. Both hand and powered torque tools can be measured, calibrated or viewed in graph mode. The T-Box™ 2 has common torque units and large measurement memory for storage of test results.

T-Box™ 2 Part numbers covered by this manual:

Parts Included	Part Number	Quantity
T-Box™ 2 Instrument with TDMS Software.	43542	1
Power supply adapter.	39979	1
USB Flash drive (Operator's Manual / Software).	61908	1
Quick Reference Guide.	34475	1
Hex Key (for stand).	24933	1
T-Box™ 2 Carry Case.	266160	1
DC Extension Cable, 1.5 M.	39998	1
Serial Null Modem Lead 2 M.	39264	1

Accessories Available	Part Number
T-Box™ 2 to 10-way lead, for Norbar Rotary Transducers.	60216.200
T-Box™ 2 to 6-way lead, for Norbar Static & Annular Transducers.	60217.200
T-Box™ 2 to no connector (for non-Norbar transducers).	60223.200
Extensive range of torque transducers.	Contact Norbar
Serial Data Lead Kit.	60248

NOTE: The suffix after the lead part number indicates the length of the lead in cm, thus XXXXX.200 = 2 metres. If Transducer leads are required of a non-standard length, the new suffix must be added to the part number when ordering (to the nearest metre).

FEATURES AND FUNCTIONS

- 10.1" Colour multi-touch screen with clear icons for ease of use.
- Highly accurate $\pm 0.05\%$ of reading accuracy ($\pm 0.1\%$ when below 5% of transducer capacity).
- Includes 6 modes for torque tool measurement: Track, Click, Dial & Electronic, Stall, Screwdriver and Hydraulic.
- Can export readings and graphs to CSV or JSON format allowing for 3rd party software integration.
- 2 Simultaneous transducer inputs.
- Automatically recognises any 'SMART' Norbar transducer.
- 5-digit resolution for all Norbar transducers.
- Continuous output of up to 100 readings per second via RS-232 or USB virtual serial devices.
- Operational from external 12v battery or mains power supply adaptor.
- Multiple Targets to indicate status of Torque & Angle results. The Targets status is shown as symbols and background colours on the display, as well as outputs on the ancillary's connector and serial port.
- Continuous Data logging of Torque or Torque & Angle results.
- Selectable frequency response for each mode of operation.
- Ancillaries connector for each transducer with analogue output & GO/NO GO control for external equipment.
- Serial Port for data output to a PC.
- 120 GB results memory.
- 2 USB ports for data transfer. Can be used with a mouse and Keyboard.
- All Peak and 1st Peak modes can be configured for either Manual or Auto Reset.
- 13 torque units.
- Displays torque only, torque & angle.
- Rear panel features 100 mm x 100 mm VESA mounting holes, allowing for easy wall mounting.

BEFORE USE

Updates

For the latest version of the T-Box™ 2 software and the latest version of this manual please visit <https://www.norbar.com/Downloads/Software-Download/T-Box-2>

Preparation

NOTE: If the equipment is used in a manner not specified by the manufacturer, the protection provided by the equipment may be impaired.



WARNING: ALLOW THE T-BOX™ 2 TO EQUALISE TO THE AMBIENT TEMPERATURE/HUMIDITY BEFORE SWITCHING ON. WIPE OFF ANY MOISTURE BEFORE USE.

Assembly and Connections

Assembly of the T-Box™ 2 onto the Stand.

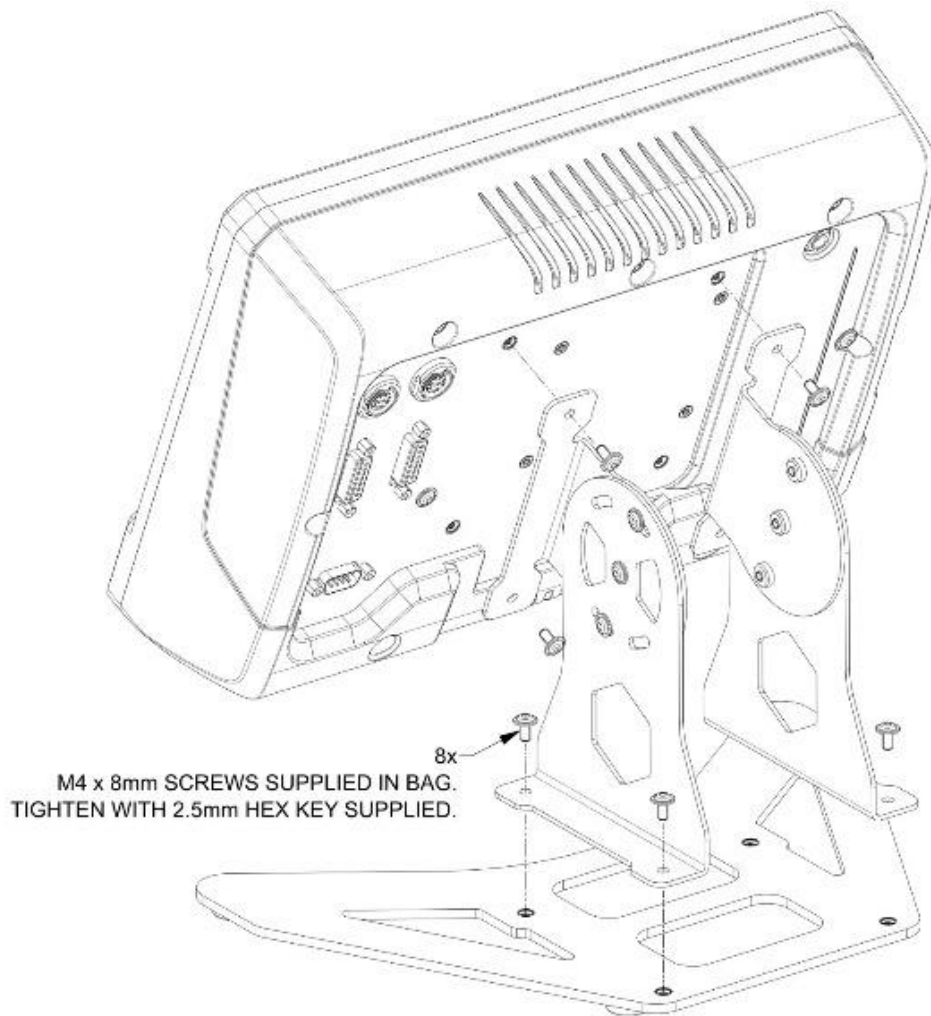

Front Panel Connectors



Power Switch

2 x USB



WARNING: TO TURN ON AND OFF THE T-BOX™ 2 USE EITHER THE POWER BUTTON ON THE FRONT PANEL OR THE POWER ICON IN THE T-BOX™ SOFTWARE.

Rear Panel Connectors

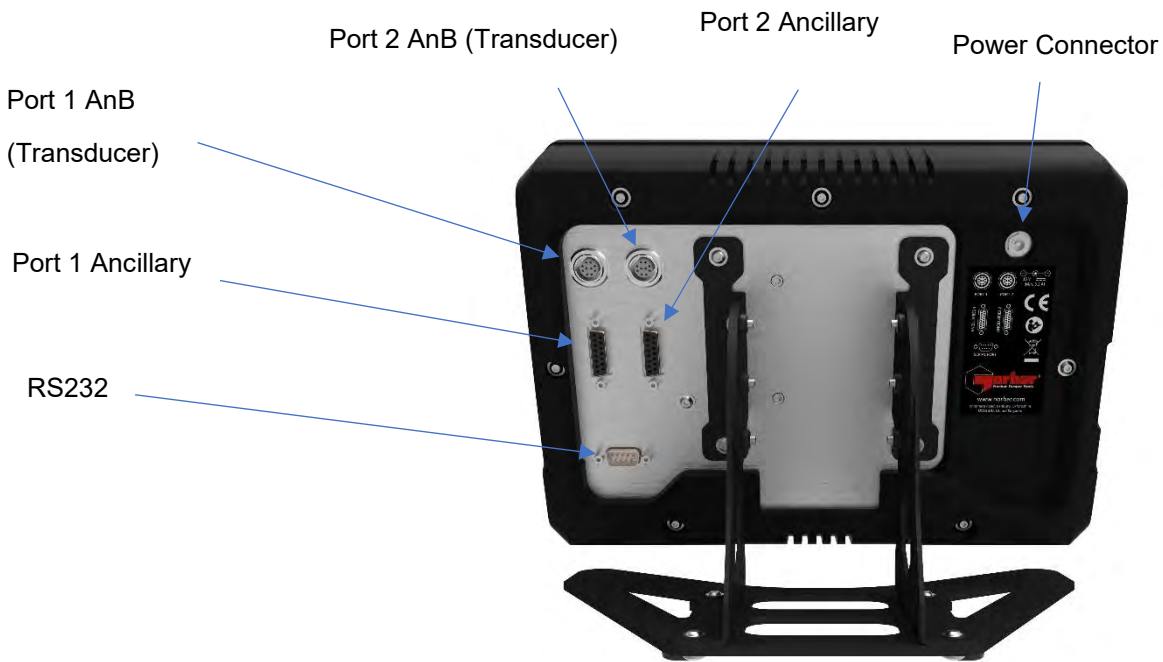

OPERATION

Power up

To power up the T-Box™ 2, connect the DC Power connector to the back of the T-Box™ 2 and plug the other end into the mains supply. Wait a few seconds for the system to initialise; you may see the power button blink on and off during this time.

Finally press the power button on the front panel. The T-Box™ 2 will take about 20 seconds to completely power up. Once completely powered the display will show two Select Task screens. This gives you the ability to work with two transducers at a time or to have two different views of the same transducer. In terms of screens and operation they are both identical.

If you need to turn off your T-Box™ 2 tap the power icon in the bottom left corner and then select 'Shut Down'.

IMPORTANT: TO TURN ON AND OFF THE T-BOX™ 2 USE EITHER THE POWER BUTTON ON THE FRONT PANEL OR THE POWER ICON IN THE T-BOX™ SOFTWARE.

TIP: The touch screen allows you to easily navigate through the T-Box™ 2 screens. A quick tap on an icon will take you to that screen and for some screen's sliding your finger up and down will scroll the items on the screen.

TIP: The Settings Icon  is always in the top left corner and this will return you to the Select Task Screen.

If you need to turn off your T-Box™ 2 tap the power icon in the bottom left corner  and then select 'Shut Down'.

Select Task Screen

This is the “main menu” of the T-Box™ 2 user interface. The T-Box™ 2 UI is a multitasking interface, comprising two separate windows which can each be assigned a task (such as managing targets, capturing a graph, or measuring a transducer).

You are free to pick any task for any window, at any time. You may for example, elect to keep a measurement task open alongside a target manager task, such that you can quickly change targets while taking measurements. Alternatively, you may wish to measure something to capture readings while graphing the output simultaneously in the other window. Or, you may wish to measure from both transducer inputs at once with a pair of measurement tasks open.

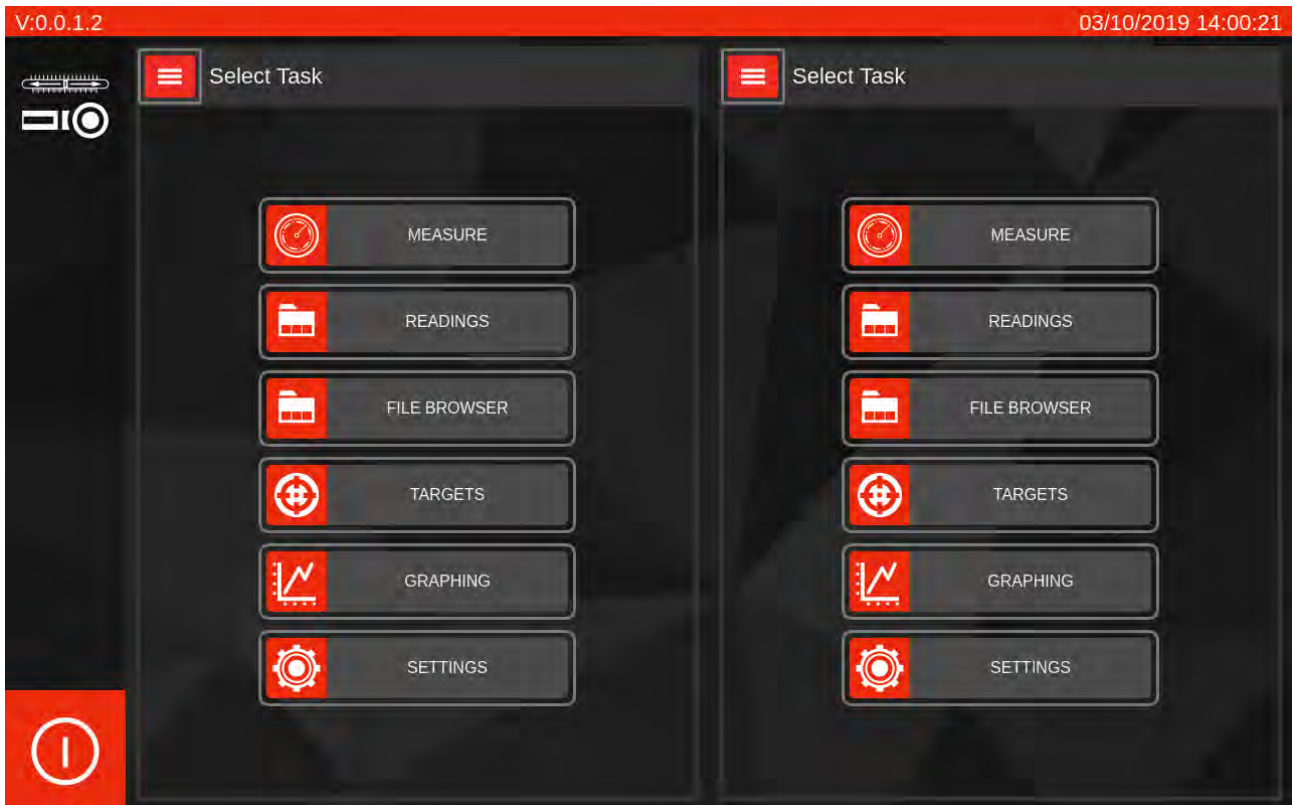

The Select Task Screen allows you to select one of the following tasks for each of the two task windows:

- | | |
|---------------------|---|
| Measure | Opens the AnB Selection Screen and then the Measure Screen. |
| Readings | Opens the Readings Screen. |
| File Browser | Opens the File Browser. |
| Targets | Opens the Target Screen. |
| Graphing | Opens the Graphing Screen. |
| Settings | Opens the Settings Screen. |

Select AnB Screen

The T-Box™ 2 contains two inbuilt AnB (analogue board) modules, allowing for simultaneous reading of two transducers.

The Select AnB menu is used to select one of the two AnB (transducer) ports for measurement and is opened when the user wishes to use the Measure Screen. Once selected you will be taken to the Measure Screen. The example below shows a torque transducer (500 N·m) connected to AnB port 1 and a force transducer (50 N) attached to AnB port 2.

If you wish to measure from both transducers simultaneously, use the second window to open a second Measure screen and select the other AnB for that screen.

To select a transducer just tap on it. If you remove or connect transducers, press REFRESH to update the changes on the screen.

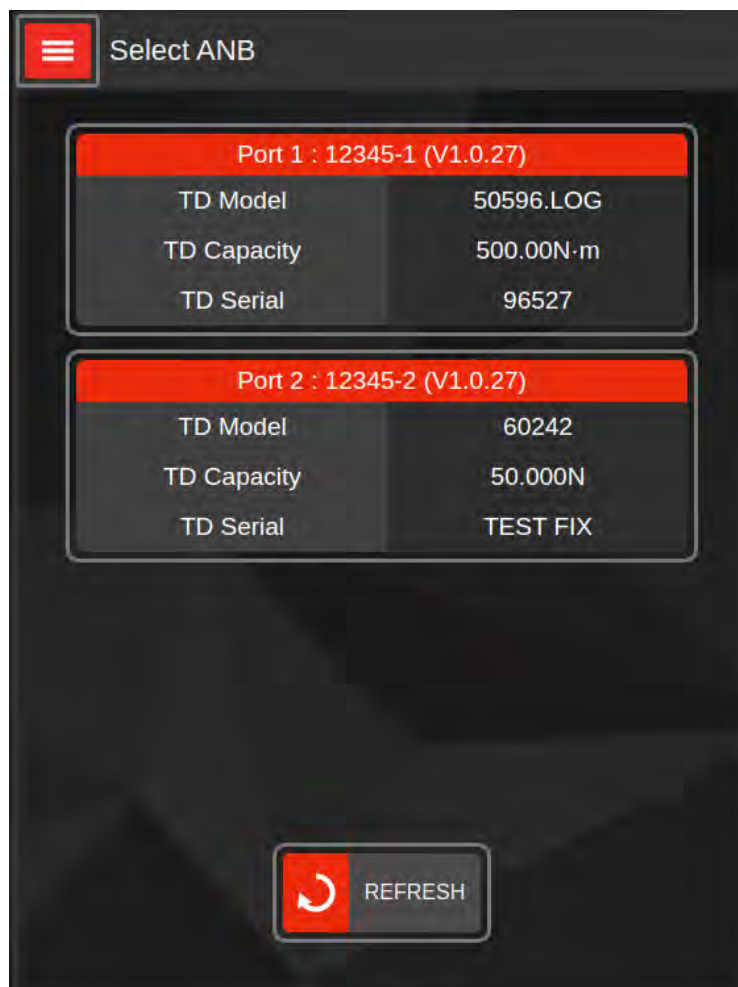

Measure Screen

The Measure Screen allows you to view live results and historic results from the selected AnB port as well as providing access to all the settings needed to set up and take a measurement. For most users this will be the most useful screen.

The image below shows all the key areas of the Measurement Screen.

See Example 1 (Page 37) - Click Wrench Torque Measurement

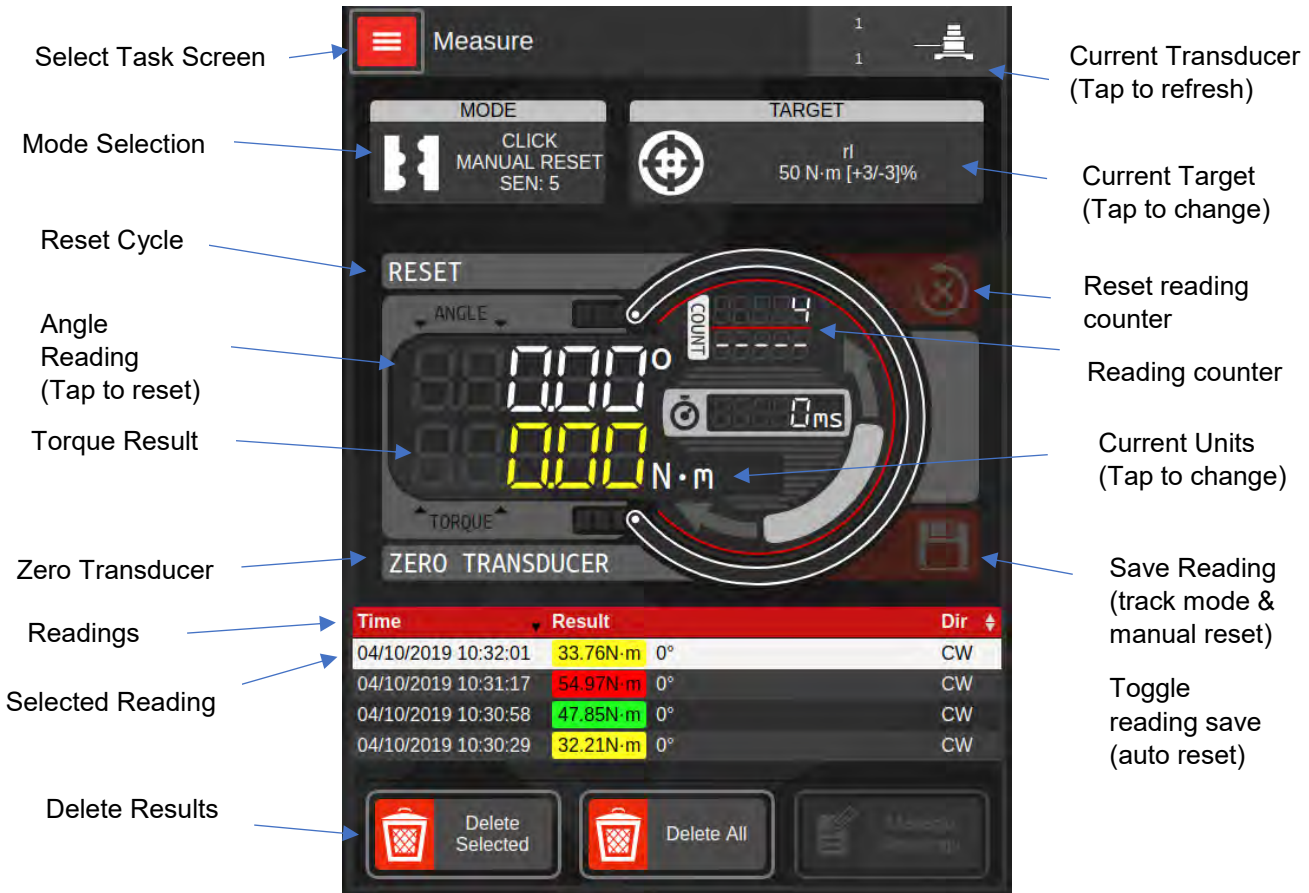

- Mode Selection** Shows the current mode. Tap to open the Mode Selection Screen (see **Mode Selection Screen**).
- Current Target** Shows the current target. Tap to open the Target Select Screen (see **Targets Select Screen**).
- Reading Counter** The total quantity of captured readings. If using a target with a defined number of readings, it will show X of Y readings captured against the target.
- Reset Counter** If using a target with specified reading count, resets the X of Y reading counter.
- Reset** Resets the current reading (if in manual reset mode). If in auto reset, this is disabled and just reads "auto".
- Zero Transducer** Zeros the Transducer.
- Save** Saves the reading (if in Track mode or in manual reset and a reading has been captured). If auto-reset is enabled, it toggles auto-save instead.

- Current Transducer** Shows the currently attached TD. Tap this to re-read the Transducer when changed. If changed, any current target will be cleared.
- Current Units** Shows the current units. Tap to open the Units Selection Screen (see **Units Selection Screen**).
- Readings** A brief summary of all readings captured with this AnB port this session. Tap Manage Readings to see a full-window breakdown and to save readings to disk.
- Delete Selected** Deletes the selected reading (if one is selected) or the last reading taken if none are selected.
- Delete All** Deletes all readings for the current AnB port.
- Sorting** By tapping Time, Result, or Dir you can sort your results.

TIP: To select a Result tap on it (Highlighted items have a white background). To un-select an item tap on it again.

TIP: Keep the Targets screen and Measure screen open side-by-side to easily manage capture of data against multiple targets. Tapping “Set Target” will automatically set the target of the adjacent measurement window.



Mode Selection Screen

Mode Selection can be accessed via the Measure Screen and allows you to configure an AnB port for different types of measurement. It is important to select the correct mode for the type of tool you are testing. The filter frequency can be used for removing high frequency pulses on Pulse Tools. Once you have selected the correct mode and filter frequency, tap SET.

TIP: You will need to scroll this screen to see all the settings.

Track	Selects Track Mode (best for slow-changing, continuous torque signals).
Click	Selects Click Mode (best for calibrating setting torque tools that click on target).
Dial	Selects Dial Mode (best for calibrating indicating tools).
Stall	Selects Stall Mode.
Screwdriver	Selects Screwdriver Mode.
Hydraulic	Selects Hydraulic Mode.
Auto Reset	When enabled this will reset the reading after a set time.
Auto Reset Mode	For peak-type modes; whether auto reset can be triggered by any drop in signal, or only when the signal drops below AFL.
Hold Time	How long it takes the Auto Reset to complete (in some modes Auto Reset may be cancelled if conditions are met, like in peak-type modes, if the signal starts to increase again above AFL).
Progressive Reset	Allows reset at the top end of a reading instead of the bottom in peak-type modes (see "Progressive Reset" section). Useful in conjunction with Linked Targets.
Broadcast Capture Trigger	When enabled, triggers the other AnB module to also capture a reading when this one does (capture a reading from two transducers at once - See "Broadcast Capture Trigger" section).
Peak/First Peak Sensitivity	This determines how sensitive the T-Box™ 2 is when detecting signal peaks in Click, Dial, Stall, Screwdriver & Hydraulic modes. If sensitivity is low, a larger drop after a peak is needed to register.
Active From (AFL)	Active From level (AFL). Valid readings will only start from at least N% of the capacity of the transducer. Peak-type readings are considered completed once the signal drops below the AFL value.

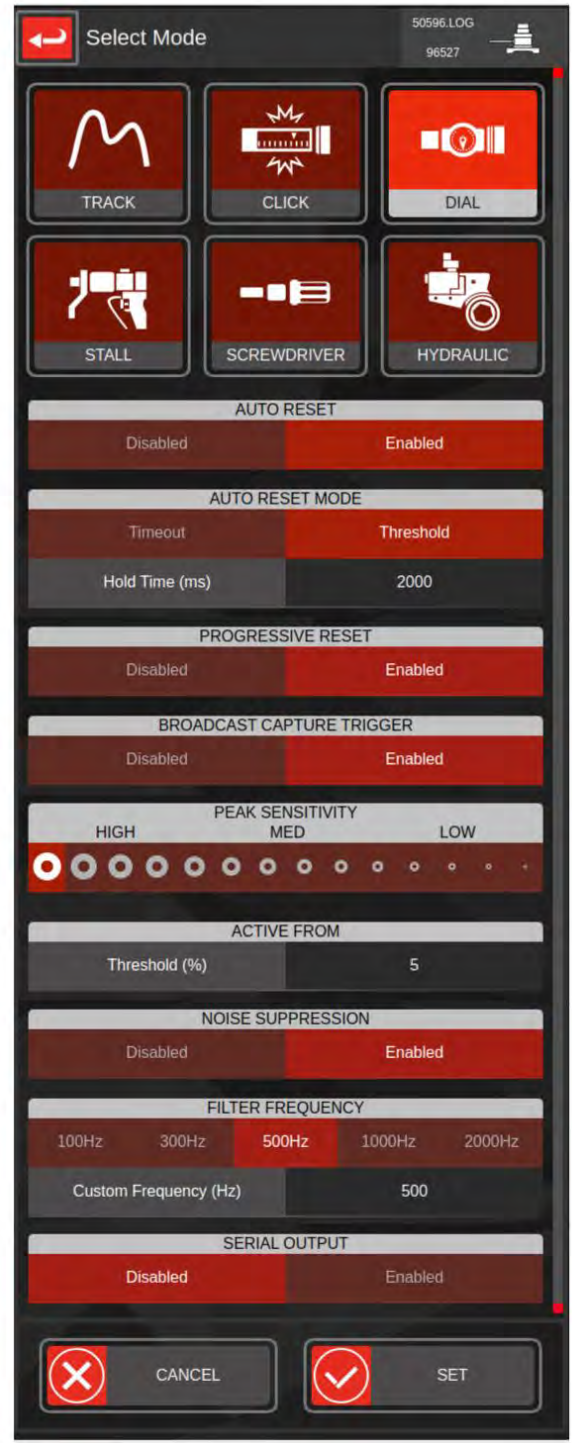

Noise Suppression Allows the user to disable noise suppression in order to capture and analyse extremely fast signals.

The data supplied in the T-Box™ 2 calibration certificate is obtained with noise suppression enabled. Disabling it may result in wider uncertainties due to noise.

The password to disable Noise Suppression is: transients.

Filter Frequency Selects an AnB module's ADC filter frequency. Signals with frequencies above the current setting are reduced. Increase the filter frequency for signals with rapid transients.

Serial Output Enable or disable serial port output of readings or live data streams for this specific AnB module (requires serial port output enabled in settings > serial ports).

Set This will set the current measurement mode based on the settings above.

Cancel Cancel mode setting; any changes will not be saved.

NOTE: Not all settings are available in all modes; some are mode-specific.

TIP: If you want to capture graphs, bear in mind the AnB mode settings will affect the capture, so it is important to consider the mode before capture begins. If you need to check or change the mode, access Mode Selection from the Measurement Screen.

The mode effects on graphing are summarised below:

Track: Best for slow-moving signals and when maximum noise rejection is required.

Click: Best for graphing the behaviour of click-type setting tools such as ISO 6789:2017 Type II Class A tools.

Dial: Best for any other scenario than those outlined above. Probably, the most common all-purpose mode to use for graphing would be Dial mode.

Stall/Screwdriver/Hydraulic: There is no difference in graphing performance between these modes and Dial mode.

Progressive Reset

Normally in peak-type modes (Dial, Stall, Screwdriver, Hydraulic), the peak reading is not captured until the reading drops and a subsequent Auto Reset or Manual Reset takes place to write the reading into memory.

However, there may be circumstances where users wish to capture readings without the signal having to drop. A good example might be when testing a gearbox or a hydraulic wrench over a large range of setpoints, where users wish to sweep through an increasing range of torque & pressure points and capture results without having to back down to zero after each reading.

If you only wanted to capture a sweep of the capacity range of a hydraulic wrench or gearbox, it is possible to just use the Graphing Screen and capture hundreds or even thousands of torque-vs-pressure points as a graph, but if you have specific targets to test against and want to express pass/fail criteria for each, then you would need to set those explicit targets and capture readings against them.

For such situations, you can use Progressive Reset. Enabling it will cause the AnB module to reset during the peak reading: the moment the transducer reading meets a PASS condition. Coupled with Linked Targets, you can capture a reading at a specific torque or pressure point and instantly progress to the next target in the chain. This lets you sweep through a range of targets in a single, smooth motion and capture pass/fail criteria as you go.

NOTE: Progressive Reset only works when Auto Reset is enabled.

NOTE: Progressive Reset only works when Auto Save is enabled and a target is set on the AnB module. If no target is set, the reset mechanism reverts to default (non-progressive) behaviour.

NOTE: Progressive Reset overrides the default reset behaviour; in peak-type modes, this means the timeout/threshold reset setting has no effect while Progressive Reset is active.

NOTE: With unlinked targets, Progressive Reset will disable Auto Save after it has taken a reading, to prevent potentially hundreds of readings being captured in an instant.

NOTE: Progressive Reset cannot be used in conjunction with rate targets that specify a minimum or maximum rate (more accurately: it can be used but will not capture useful rate data and rate guidance indicators will not work).

TIP: Linked targets used with Progressive Reset should be set with small tolerances to ensure the reading is captured as close to the desired value as possible. For increasing readings, like sweeping up through the capacity of a hydraulic torque wrench, try using a lower tolerance of 0% and a small upper tolerance of <1%.

TIP: Do not sweep too quickly through Linked Targets with Progressive Reset; if you go too fast you may overshoot the pass band for the target; if this happens the sweep will fail and you will need to reset the AnB module and start again.

Broadcast Capture Trigger

Sometimes you may have a test to perform that involves more than one transducer, such as when using a hydraulic wrench; in this case you may be interested in measuring both torque and pressure at the same time. Specifically, you may be interested in measuring the torque achieved at a specific pressure and have two transducers (one pressure and one torque) connected for this purpose.

You can measure torque vs pressure using the Graph Screen, but if you have specific targets to test against and want to express pass/fail criteria for each, then you would need to set these explicit targets and capture readings against them.

To capture such results, enable Progressive Reset and Broadcast Capture Trigger on the AnB module measuring pressure and set the desired pressure target. When the pressure target reaches a pass condition, the pressure AnB module will reset and capture a reading and simultaneously trigger a capture from the torque AnB module. The result is a pressure reading and a corresponding torque reading. When combined with Linked Targets, you can capture an entire range of pressure vs torque readings in one sweep.

It is not necessary to set a corresponding target on the AnB module receiving the broadcast trigger (in this example, the torque AnB); however, you can do so if you want to express a pass/fail condition for the recipient AnB module's reading when it is taken. Linked Targets will also work on the recipient AnB; so, you can specify a linked range of targets on the broadcasting AnB (which will trigger captures when their pass conditions are met) and a corresponding range of targets on the recipient AnB, if you wish.

TIP: In order to respond to a Broadcast Capture Trigger, the recipient AnB module must be in use. A Measuring Screen or a Graphing Screen can be used to ensure the desired AnB is active and able to capture readings in response to capture triggers. For example, two Measurement Screens open side by side (one for each AnB module) will suffice.

NOTE: In peak-type modes (Dial, Stall, Screwdriver, Hydraulic) Broadcast Capture Trigger only works when Progressive Reset and Auto Reset is enabled.

NOTE: AnB modules ignore Broadcast Capture Trigger events in Click mode; this is because the measurement is reliant upon external factors (when the tool produces a click). However, an AnB in Click mode can broadcast a BCT event to other AnB modules when the tool clicks.

TIP: Do not enable Broadcast Capture Trigger on more than one AnB module at the same time.

Units Selection Menu

The Units Selection menu is where you select the current measurement units for a Measure screen.

To access this screen, tap the units in the measurement dial (see Measure Screen section of the handbook, “Current Units” for a look at where to tap). Then pick a unit to switch to. If you change your mind and do not wish to switch, just pick the units you were using before.

If certain units have been disabled in the Settings >> Units Screen, then they will appear greyed out and cannot be selected.

NOTE: If you set a target, the Measure screen will automatically switch to the correct units for that target.

NOTE: The units available for selection will vary depending on the type of the currently attached TD (force, torque or pressure). The screenshot below shows Torque units.

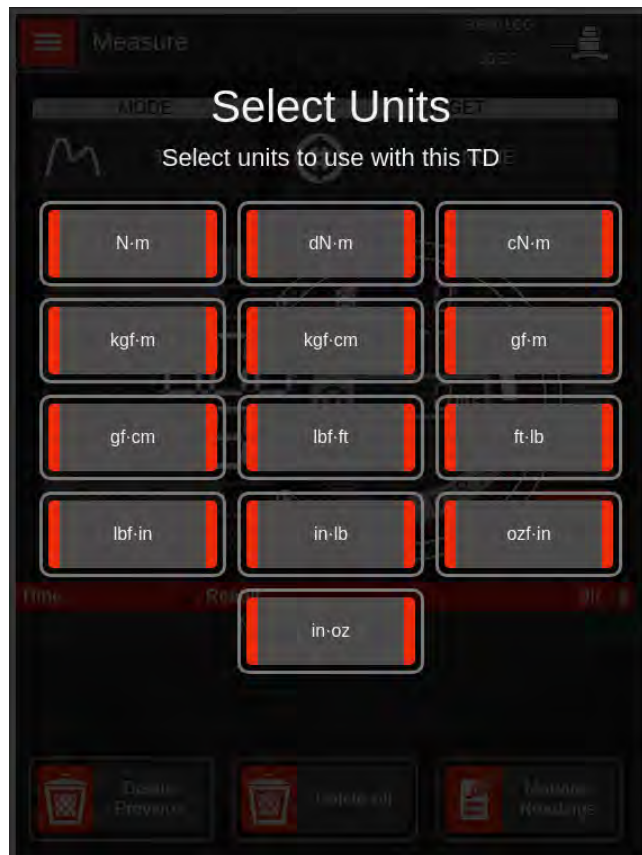

Readings Screen

The Readings Screen is used to manage all readings from all AnBs attached to the system. You can also choose to focus on the readings from just one AnB port if you wish by filtering out other readings.

Each result has a time and date, the recorded values, units and direction (which in the case of force or pressure, may be “positive” and “negative” instead of “CW”/“CCW”).

The result is colour coded depending on the Target limits used:

Green: reading OK/pass

Yellow: Reading too low (below limit)

Red: Reading too high (above limit)

If no target was set when the result was saved, then there is no colouration.

So, for a Target of 50 N·m +3% / -3% where the result is 50.67 N·m the result will be green (pass). If the result was too low (43.74 N·m) the colour will be yellow and too high (53.60 N·m) will be red.

The same colouration applies to angle and rate if the target contained limits for those measurements.

TIP: To select an item tap on it (Highlighted items have a white background).
To un-select an item tap on it again.

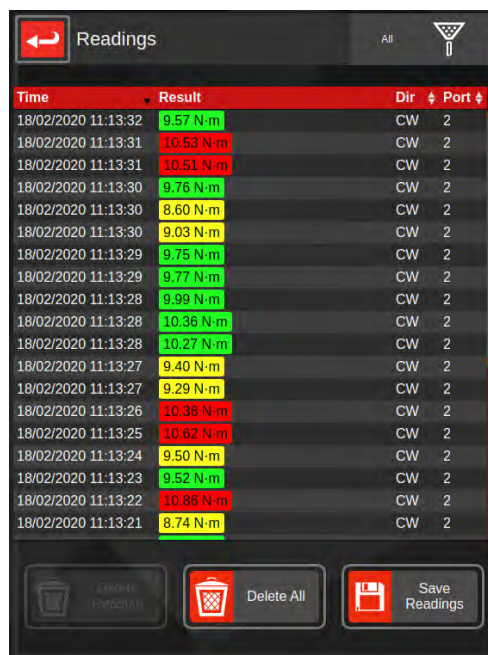

The screenshot shows a mobile application interface titled "Readings". At the top right, there is a filter icon and the text "All". Below this is a table with columns: "Time", "Result", "Dir", and "Port". The "Result" column contains numerical values followed by "N·m", color-coded as green, yellow, or red. The "Dir" column contains "CW" and the "Port" column contains "2". At the bottom of the screen, there are three buttons: "LIMITS (2020/01)", "Delete All", and "Save Readings".

Time	Result	Dir	Port
18/02/2020 11:13:32	9.57 N·m	CW	2
18/02/2020 11:13:31	10.53 N·m	CW	2
18/02/2020 11:13:31	10.51 N·m	CW	2
18/02/2020 11:13:30	9.76 N·m	CW	2
18/02/2020 11:13:30	8.60 N·m	CW	2
18/02/2020 11:13:30	9.03 N·m	CW	2
18/02/2020 11:13:29	9.75 N·m	CW	2
18/02/2020 11:13:29	9.77 N·m	CW	2
18/02/2020 11:13:28	9.99 N·m	CW	2
18/02/2020 11:13:28	10.36 N·m	CW	2
18/02/2020 11:13:28	10.27 N·m	CW	2
18/02/2020 11:13:27	9.40 N·m	CW	2
18/02/2020 11:13:27	9.29 N·m	CW	2
18/02/2020 11:13:26	10.36 N·m	CW	2
18/02/2020 11:13:25	10.62 N·m	CW	2
18/02/2020 11:13:24	9.50 N·m	CW	2
18/02/2020 11:13:23	9.52 N·m	CW	2
18/02/2020 11:13:22	10.86 N·m	CW	2
18/02/2020 11:13:21	8.74 N·m	CW	2

Filter 

This will allow filtering of the results by which AnB port took the reading.

Delete

This will delete the selected reading (tap a reading to select; selection is highlighted in white).

Delete all

This will delete **all** currently shown readings. If you have filtered the list, it will delete all readings shown based on current filtration settings (leaving the rest).

Sort Readings

Readings can be sorted by time, direction or result by tapping the relevant table header.

File Browser

The File Browser allows you to browse the filesystem and manage T-Box™ data files such as Target files, Graphing captures & Readings data. Use the File Browser to copy, rename and delete these and any other files and folders, as well as copy data to or from a USB memory device. You can also directly open certain T-Box™ data files from within the File Browser; see next page for details.

TIP: The File Browser tries to remember what folder you were in the last time it was used. This can be useful when working with lots of similar files (such as editing many Target files).

TIP: To select an item tap on it (Highlighted items have a light red background)
To un-select an item tap on it again.

TIP: To open a folder double tap on it
To open a file, double tap on it, or select it and then tap the Select button.

TIP: You may need to scroll this screen to see the full list of folders/files.

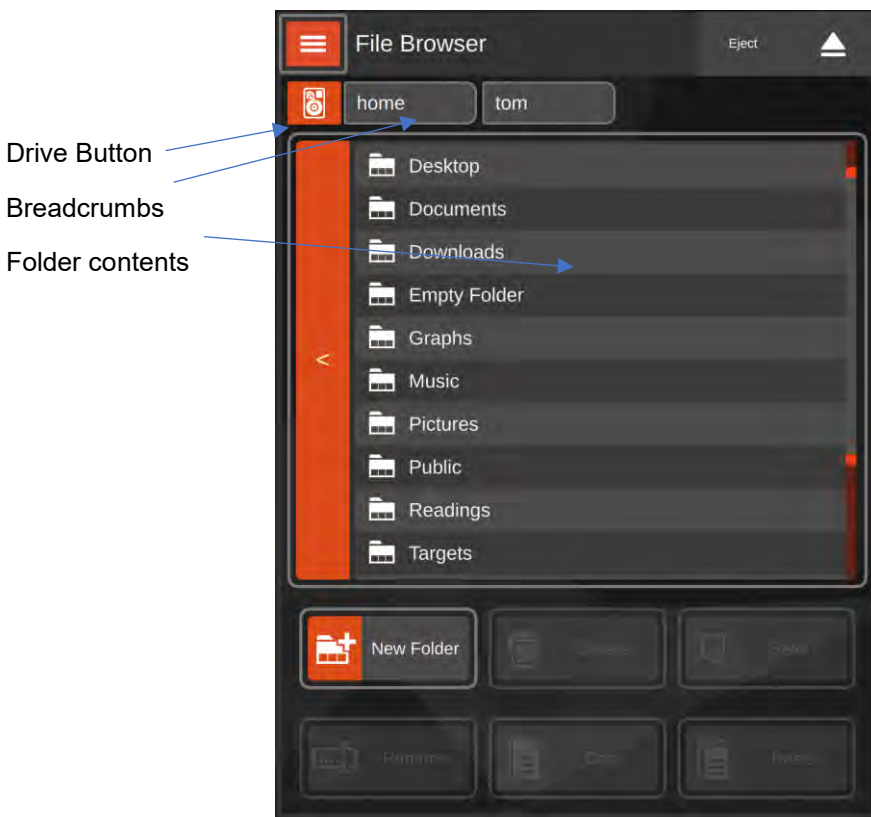

- Eject** This will allow you to safely eject a Memory Stick.
- New Folder** This will create a new folder in the currently open folder.
- Delete** This will delete the currently selected item.
- Rename** This will allow you to rename the currently selected item.
- Copy** This will copy the current selected item (can be a folder or a file).
- Paste** This will paste the last item copied (can be a folder or a file).
- Drive Button** This will allow you to select the main storage or Removable Media (USB memory).
- Breadcrumbs** These indicate the currently open folder path; tap to jump back up the path.
- Folder Contents** This is the contents of the current folder as shown by the Breadcrumbs.
- Home** This will return you to the home folder of the currently selected drive.

By default, the File Browser starts in the /home/user folder. This is the default directory (like the user folder on a Windows PC). You should see the Drive Icon looks like a hard disk, to indicate “internal memory” as the current data source. The breadcrumbs to the right of the Drive Button show the current location, like below:



The folder contents window will reflect the current contents of the /home/user folder, showing all files and folders.

If you navigate to the /home/user/Graphs folder (by double-tapping Graphs in the Folder Contents window) the folder will be opened and the breadcrumbs will update to show the new location:



You can also use the breadcrumbs to navigate back up the path. Tap the “user” or “home” breadcrumbs to jump back to that location.

In addition to navigating and managing files, you can also use the File Browser to directly open certain T-Box™ data files:

File Type	File Browser behaviour
Graphing preset file (.tbgpf)	Opens Graphing Screen and attempts to load the preset if compatible with the current transducer and AnB configuration.
Graphing data file (.tbgf)	Cannot open directly; for use by customers who wish to import data into their own software.
Graphing data file (.csv)	Cannot open directly; install spreadsheet software or copy the file to a PC with spreadsheet software.
Readings file (.tbrf)	Opens Readings Screen and offers to load the file or combine its data with any current readings.
Readings file (.csv)	Cannot open directly; install spreadsheet software or copy the file to a PC with spreadsheet software.
Targets file (.tbtf)	Opens Targets Screen and loads the list of targets.
T-Box Update file (.deb)	(Software v1.0.2.1 and later) If it's a valid update file, asks if the user is sure and starts the installation procedure.

CSV format files cannot be opened - to view CSV files on T-Box™ 2, install spreadsheet software like LibreOffice Calc or FreeOffice PlanMaker, or alternatively, use File Browser to copy the files to a memory stick and take them to a computer with spreadsheet software installed.

Readings, Targets and Graphs are stored in the following folders:

- /home/user/Graphs
- /home/user/Readings
- /home/user/Targets

You can also use the File Browser to delete, or copy files to and from a USB memory stick. This is useful if you want to share Targets with another T-Box™ 2, for instance, or send Graph data or readings to a PC.

See Example 2 (Page 38) - How to copy Results Folder to Memory Stick

TIP: Two file browsers can be opened side by side to facilitate easy copying of files from one window to the other. This can be useful if you are working with lots of files at once, such as copying lots of individual Results files to a USB memory stick.

Targets Screen

The Targets Screen allows you to manage your targets. Targets specify test conditions and pass/fail parameters against which you can take measurements and store results. You can specify a target transducer reading, angle and ISO 6789 rate timings against which to take measurements, as well as specify direction and number of readings.

For instance, a target might measure **Torque Only** in **N·m** in a **Clockwise** direction, specifying a pass value of **50 N·m** and an allowable upper and lower range of **+3% / -3%**.

In older T-Box™ generations, the targets list was a singular, flat list of all the targets stored on the instrument. But in T-Box™ 2, you can have thousands of different target lists; each one comprising a separate .tbtf Targets file on the T-Box™ internal storage. This allows for much better organisation of targets. For instance, you might choose to categorise targets by which type or which capacity of tool they are for. You can use the Targets file capability and the File Browser to store, categorise and organise targets however you wish.

See Example 1 (Page 37) - Click Wrench Torque Measurement

TIP: You may need to scroll this screen to see the full list of Targets.

**TIP: To select an item tap on it (Highlighted items have a white background)
To un-select an item tap on it again.**

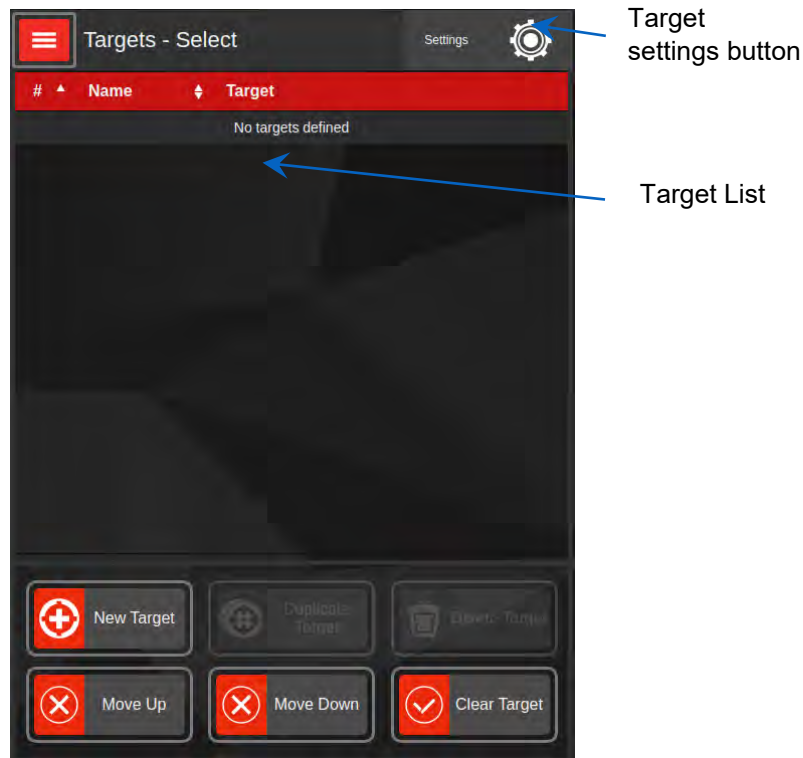

New/Edit Target	This will allow you to create a new Target. If a target is already selected in the Target List, it will allow you to edit the selected target.
Duplicate Target	This will allow you to duplicate the selected Target.
Delete	This will delete the selected Target.
Set/Clear Target	This will set the currently selected Target as the measurement Target, or clear the active target if no target is selected.

When you first open the Targets Screen, it creates an empty Targets file in the following default location:
/home/user/Targets/single_targets.tbtf.

This file will be shown at the top right corner of the Targets Screen. If you wish to use your T-Box™ 2 like an original T-Box™, then there is nothing else you need to do, just start adding new targets and they will be saved into the default list.

However, if you wish to create your own targets files and maintain separate, organised lists, then tap the Targets File button to create or select a different file. You will be taken to the File Browser to select a save location, or to select an existing file as appropriate.

TIP: If your work involves changing targets frequently, you may wish to keep the Targets Screen open alongside the Measurement Screen, so you can quickly change targets while taking measurements. When opened directly from the main menu or File Browser, the Targets Screen will set or clear targets on whichever AnB port is being actively used in the other window.

TIP: If your work involves changing targets frequently and those targets are always captured in the same sequence, you may wish to define them as a set of Linked Targets instead. This way, the AnB module will automatically step through the linked targets in sequence when each target has taken its readings. For more details see Linked Targets.

NOTE: The user interface will memorise what Targets file you were last using so that it can open it again for your convenience the next time you open the Targets screen. The memory depends on AnB context; it will remember the different Targets files last used for each AnB module as well as the last file used outside the context of any AnB and Measurement screen. This makes it easier to work with multiple AnB modules and Targets files without constantly having to select each file.

Target Settings

Target settings lets you change settings pertaining to the current target file, as well as change the current target file and general settings.

Current Targets File Tap this to create or load a different Targets file than the one currently displayed. You can create or load targets from the Targets folder, or elsewhere, including directly off a USB memory stick. When you create or load another Targets file, the UI will take note of it and attempt to re-load it later for your convenience when you return to the Targets Screen in the future. The UI can memorise a single last-used Targets file in addition to a last-used Targets file for each AnB module.

Implicit AnB Selection When enabled, the Targets screen will attempt to guess which AnB module you want a target to be set on, if the answer is not already obvious. For instance, if you opened the Targets screen from the Measurement screen of an active AnB module, the implication is you want to set a target on that AnB module, so the Targets screen does not need to ask your intentions.

If you disable implicit AnB selection, the Targets screen will never attempt to guess which AnB module you are interested in, instead asking you every time to confirm which AnB module to use. This can be useful in scenarios where the AnB you want to change isn't the one typically implied. For instance, while using a Measurement screen and a Graphing screen and trying to change or clear a target via the Measurement screen's Targets button on the other AnB module.

Target Type Set whether the current targets file comprises Single Targets or Linked Targets. The default target type is Single Targets, where each target in a Targets file is considered separate. When a Targets file is set to Linked, its targets are treated as a list of Linked Targets.

When an AnB module is set such a Linked Target, it will automatically jump to the next target in the list once the target's reading(s) have been taken. If a target requires multiple readings, it will proceed to the next target once all necessary readings have been taken.

You can change target at any time, starting from any point in the target list and the AnB module will start following the list from there.

For more information see [Linked Targets](#).

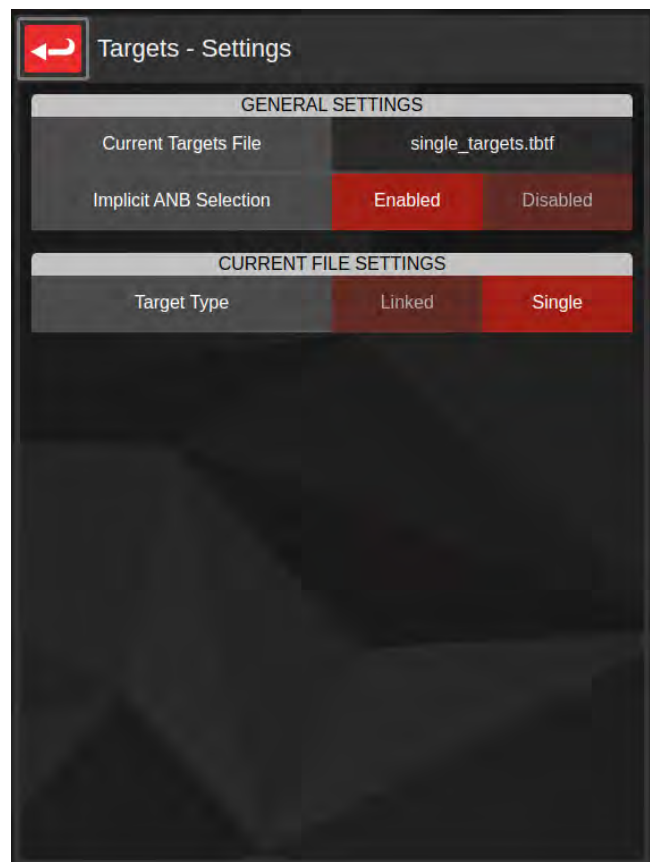

Target Editor

When making a new target, the editor is designed to guide you through the steps needed to set up your target.

When you first open the screen, most of the options will be hidden. First you will need to select a target type (force, pressure or torque) followed by the desired units and whether angle is required. After that the remaining options will unlock. If you are editing an existing target, all options will already be unlocked.

Shown below is the full editor layout; to access all options, use your finger to scroll up or down. Note that your screen will look a little different depending on your target type and whether angle is involved.

For example, if no angle is required then the angle target and angle trigger source fields will be hidden. Also, if you change the target type, all references to “Torque” will change to match, i.e. “Pressure Target” and “Stop Pressure”.

See Example 1 (Page 37) - Click Wrench Torque Measurement

TIP: You may need to scroll this screen to see the full list of settings.

Select Unit	This will set the units of measurement for this target. Available units will change depending on target type (Torque, Pressure or Force).
Torque Only	This will set a Torque only target (no angle).
Torque Then Angle	This will set a Torque then angle target.
Name	The name for this target in the target list.
Direction	You can select Clockwise, Counter-Clockwise or both directions for the target.
Qty of Readings	This is how many readings you want to take with this target.
Stop Torque	If you want the Ancillary port Stop Torque output to activate at a certain value, set the desired transducer reading at which the ancillary port Stop signal is asserted.
Torque Target	This is the target torque.
Lower/Upper Limit	Set the allowable range for a “pass” on the target value.
Rate Control	Specify an ISO 6789:2017 rate of application of torque. The Measurement Screen dial will guide you through the cycle to help meet the timings when the cycle begins.
Direction	The direction of the angle measurement can be set to either Clockwise, Counter-Clockwise or Both.
Angle Target	This is the target value for the angle in degrees.
Lower Deviation	This is the allowed deviation below the target angle in degrees.
Upper Deviation	This is the allowed deviation above the target angle in degrees.

Trigger Internal trigger allows angle measurement to start when the Trigger Torque value is reached.

External Trigger allows angle measurement to start when the Ancillary line 'External Snug Trigger Input' is triggered.

Angle Trigger Torque This sets the Trigger Torque value for Internal Trigger, at which point the angle measurement begins.

NOTE: The Save Target button will not activate until the target is valid to be saved. If it is not active, please check if you have missed any important fields.

TIP: If you edit a target which an AnB module is already using, the changes will not take effect right away. Set the target on the AnB again to ensure the change is respected.

Linked Targets

Linked Targets are targets which move on successively to the next target upon capture of all readings; every time you capture a reading for a linked target, the AnB module on which that target is set will automatically load the next target in the list. If a target requires more than one reading, the AnB module will move on to the next target once all necessary readings are taken.

The T-Box™ 2 also supports retrying of linked targets; in the event a bad reading is taken on a Linked Target, if the user presses "Delete Previous" on the Measurement screen, they will be offered the option to revert to the previous Linked Target if necessary.

Linked Targets are especially useful in scenarios where you have a repetitive series of targets to test against; such as, calibrating a torque wrench.

Linked Targets are also important when using Progressive Reset to calibrate hydraulic wrenches; used with Progressive Reset, Linked Targets allow you to sweep smoothly through a tool's capacity range and gather readings against targets as you go.

Configuring Linked Targets

In previous T-Box™ generations, users had to create all the targets in advance and then exhaustively specify which target would be "next" for each target they wanted to link. In T-Box™ 2, you simply set any Targets file target type to "linked" in the Targets screen settings; with this, all targets in that file will be treated as a linked list. You can do this with an empty Targets file, or one already full of single targets; it doesn't matter. You can change between Single and Linked target types for any Targets file at any time.

It's also very easy to modify Linked Targets in T-Box™ 2, for instance by changing the order of the linked target list. Just select a target and move it up and down the list with the "Up" and "Down" buttons in the Targets screen.

Beyond that, Linked Targets are managed exactly the same way as normal (single) targets; in terms of creating, editing and deleting targets, it all works the same way.

TIP: Don't keep targets with different unit types (such as force and pressure) in the same Linked Targets file; the AnB module won't be able to switch to targets that don't suit the currently attached transducer.

TIP: Only keep targets you want linked together inside a Linked Targets file. All targets in a given file will be treated as linked together when the file's target type is set to "linked".

TIP: If you change the order of Linked Targets which an AnB module is already using, the changes may not take effect right away. Set the target on the AnB again to ensure the change is respected.

TIP: If you change a Targets file's target type (from single to linked, or vice-versa) while an AnB module is already using its targets, the changes may not take effect right away. Set the target on the AnB again to ensure the change is respected.

TIP: You can select any Linked Target in the list as a starting point by setting that target on the AnB module. The AnB will automatically continue on from there, as if that were the start of the list.

Graphing Screen

The Graphing Screen allows you to capture graphs of transducer signals in a variety of sample rates from 1Hz to over 300Hz. When first opened it will start a live preview of transducer reading vs time for every AnB port that currently has a transducer attached. This means you may see one, two or no lines on the graph depending on what is connected to the AnB ports when the graphing feature is started.

TIP: To refresh attached transducers, use the Refresh button from the AnB selection screen, accessed from the Measure button on the “Select Task” main menu.

The Graphing feature is very flexible. You can plot two different transducer inputs vs time, or one vs the other on the X and Y axes. You could plot a single transducer’s angle vs time and torque vs time in the same graph. You could plot angle vs angle across two transducers and torque vs torque, or torque vs pressure, in the same graph.

Despite this flexibility, it’s also quite easy to use. To set up a graph to suit your needs, just tap one of the XY axis pair buttons at the bottom of the screen. This will open the axis configurator, where you can choose the X and Y axis data source, displayed units, range and the colour the axis is plotted on the display.

Captured graph data can be saved as a CSV file for import into spreadsheets, or as a .tbgf JSON-formatted data file for import into 3rd-party software. If you install spreadsheet software directly on the T-Box™ 2 you can review CSV files locally.

To see how graph data might be shared with a computer, see Example 2 (Page 38) – Copy Readings Folder to Memory Stick. Note that graph data is stored in the Graphs folder.

- Folder Icon**  Tap to change the drive/folder where the graph data is stored. The T-Box™ 2 will also create a “Presets” folder inside this one to store graph preset files.
- Rec/Clear** Start recording or clears any already captured graph data.
- Save** Save recorded graph data in JSON or CSV format.
- Settings** Open the Graphing settings menu.
- X1 Y1 / X2 Y2** Live axes state and values. Tap to set up an axis pair (set X & Y data source, units, range, sample rate & colour).

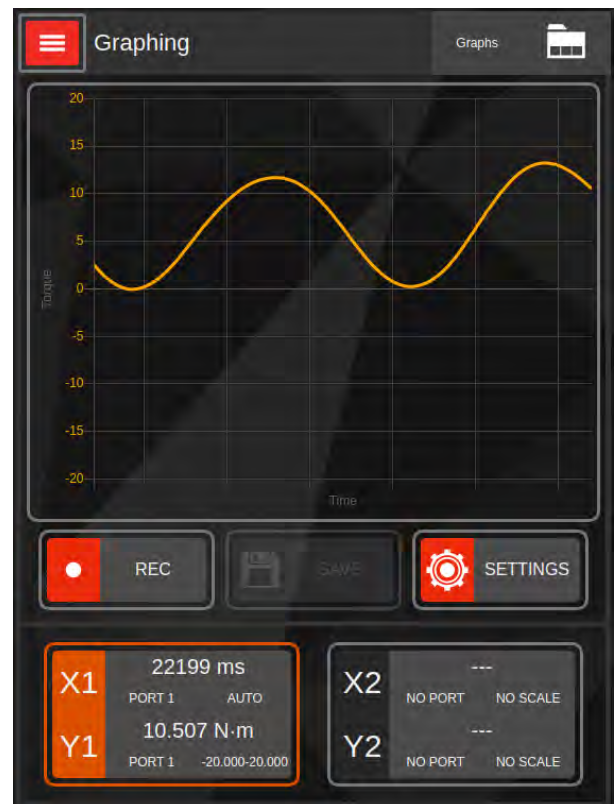

Axis Configurator

There are two X/Y axis pairs per graph and by default, both will be activated if both AnB ports have a connected SMART transducer. Use the Axis Configurator to set up or disable an axis pair on a graph.

- X/Y Port** Choose the source AnB port from which to read data.
- X/Y Type** What type of data to plot (TD value, Angle, or Time).
- X/Y Unit** How to express the reading (locked to degrees for angle and ms for time).
- Show X/Y Scale** Enable or disable the scale on that axis of the graph.
- X/Y Min/Max** Set the axis scale (auto scale, or custom value, or TD min/max value for TD axes).
- Axis Colour** Set the colour plotted on the graph.
- Sample Rate** Change the sample rate (default 30Hz).
- Disable Axis** Shuts down axis and removes the plot line from the graph.
- Done** Return to Graphing Screen.

NOTE: If an axis data Type is set to "Time" it will be forced to the same source port as the other axis in the pair. This is because the graph can't plot the time axis of one AnB port vs the value axis of another.

TIP: The maximum graph capture depth is over 1.17 a.con samples per axis. This is enough for continuous capture of between one hour and two weeks, depending on sample rate. Choose a sample rate appropriate to the speed of the measured signal and desired length of the graph.



Graphing Settings Menu

The Graphing settings menu lets you configure key graph settings and manage graph presets.

Graph presets are configuration files that you can save and load to quickly set up graphs. If you regularly have to change settings when opening up the Graphing menu, then it would be worthwhile to create presets instead. To create one, set a graphing session up how you want it (i.e. all desired axes, units, ranges, sample rates, etc) and then enter the graph settings menu and click Save under the Preset File option to save.

To load a preset, either use the load button in Graphing settings, or directly open a graphing preset from the File Browser.

You can also designate a default preset to override the default settings when the Graphing task opens. This can be useful if you regularly have to change settings when opening up the Graphing menu, but the changes you make are the same every time. If you select a default preset, the Graphing task will always open with the designated settings unless you are deliberately opening a different preset.

Max Graph Duration - Set an upper limit on how long a graph recording can be. Set to zero to disable the limit (graph will stop when it runs out of memory; this varies from roughly an hour to about two weeks, depending on graph sample rate).

Default Sample Rate - Set the sample rate new graphing sessions default to. This will be overridden if any current or default presets are loaded.

Graph Data Directory - Set the folder in which graphs are stored when saved. This is the same as using the folder button in the top-right of the main Graphing screen. The T-Box™ 2 will also create a “Presets” folder inside this one and store presets there.

Current Preset - The currently loaded preset file, if any.

Preset File Save - Save the current graph axes configuration as a preset for later retrieval.

Preset File Load - Load a preset graphing configuration.

Default Preset - The currently configured default preset file, if any.

Default Preset Clear - Clear any default preset. The graph will open with default settings instead.

Default Preset Select - Designate a preset file to use as the default preset whenever opening the Graphing task.

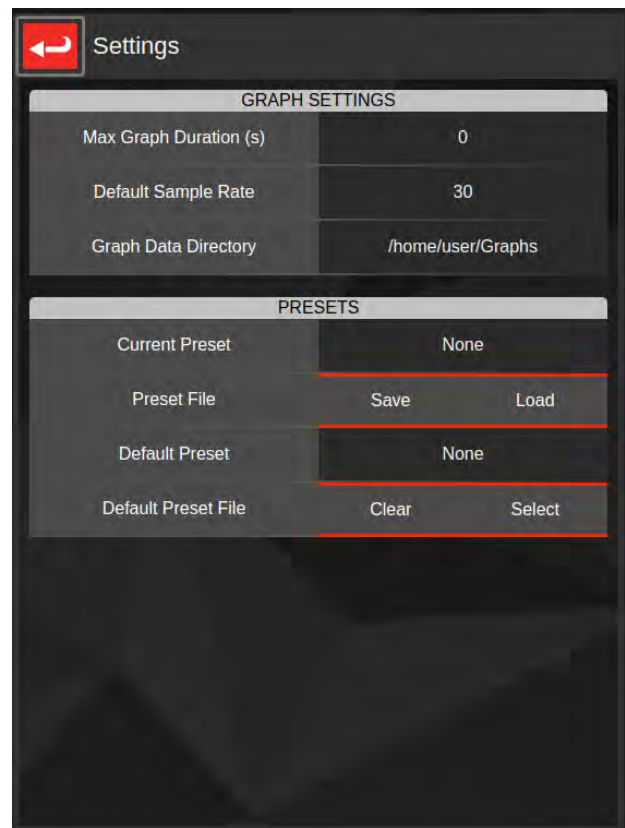

Settings Screen

The Settings Screen allows you to configure and change various system settings.

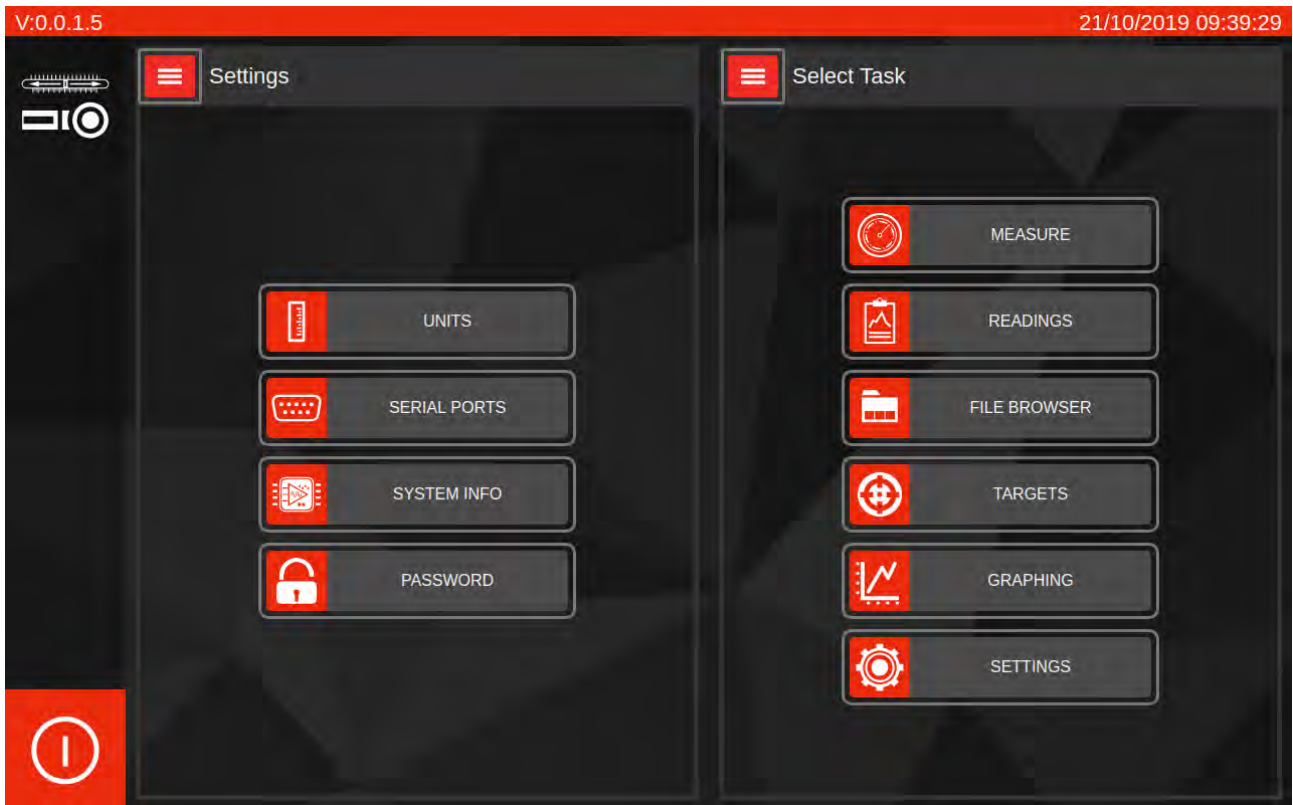

Units	Opens the Units Screen.
Serial Port	Opens the Serial Port Setup Screen.
System Info	Opens the System Info Screen.
Password	Opens the Password Screen.
License	Opens the License Agreement.

Units Screen

This screen allows you to select available units. Disabling a unit will mean it cannot be selected from the Target screen. This can be handy if for example all your measurements are in N·m

TIP: You will need to scroll this screen to see the full list of units.

Serial Port

Here you can set up the configuration of the serial port Baud rate, Data bits, Stop bits, Parity and Flow control.

As well as the format of the data the output can be configured. It is important that the serial port configuration matched the configuration of the receiving device otherwise no data or corrupted data may be received.

TIP: You will need to scroll this screen to see the full list of settings.

System Info

Here you can see details about your T-Box™ 2 system and perform firmware updates on the AnB modules.

Password

Tap to set, change or remove a password for the user interface. When set, the following activities are password-protected:

- All system settings menus.
- Creating/editing/re-ordering targets (users can set, but not modify targets).

To set a password, tap the password button and type in the new password. To change it, tap it again, enter the password when challenged and then enter the new password. To remove a password, do the same, but do not enter anything in the New Password entry box. The UI will announce that the password was cleared.

Software Update Procedures

The T-Box™ 2 has been designed to allow the end user to easily update the user interface software as well as the firmware on the AnB modules. These procedures are outlined here, but newer ones may be available alongside future updates.

Visit <https://www.norbar.com/Downloads/Software-Download/T-Box-2> to download the latest software for the T-Box™ 2 and the latest update procedures. Updates come in the form of .deb package files and usually are named with the “tbox_” prefix followed by a version number, such as “tbox_1.0.2.1.deb”.

Updating the User Interface - Version 1.0.2.1 and later

In software versions prior to v1.0.2.1, users would perform a UI update via the operating system. In software version 1.0.2.1 and later, users should be able to perform an update directly via the File Browser, which is even easier. If you are already on version 1.0.2.1 or later, but wish to use the operating system method, follow the instructions for updating versions prior to 1.0.2.1.

1. Copy the “tbox_x.x.x.x.deb” update file to a memory stick and put the memory stick into the T-Box™ 2.
2. Open the File Browser in the user interface, tap the drive button and change to Removable Media
3. When you find the update file, double-tap it or highlight it and press “Select” to trigger an installation
4. The UI will check the file is genuine and warn you of any issues (such as if the version is older than the one currently installed) as well as checking you wish to proceed.
5. If the user wishes to proceed, they will be asked to type in the system password (NorbarTBOX)
6. The UI will lock for a few minutes while installation proceeds. If any error occurs (such as the user typed the wrong password) they will be notified.
7. When finished, the UI will notify you that it is done and it needs to close. Press the Finish button to close the UI.
8. Re-launch the new user interface to open the newly updated version. The version string in the top left of the screen should now have changed.
9. Check if the AnB modules also need updating. See “Updating the AnB Modules”.

Updating the User Interface - Versions prior to 1.0.2.1

In software versions prior to v1.0.2.1, users should perform a UI update via the operating system. To do this you will need a memory stick and a USB keyboard.

1. If the T-Box™ 2 software is running tap the power icon and choose “Exit to Desktop”.
2. Copy the “tbox_x.x.x.x.deb” update file to a memory stick and put the memory stick into the T-Box™ 2.
3. When the file browser appears double click on the tbox_n.n.n.n.deb file.
4. The Package Installer will pop up. Click Reinstall Package.
5. Enter the password (NorbarTBOX) and press ‘enter’.
6. When the installation has finished, tap Close.
7. Press the power button and tap Restart.
8. The T-Box™ 2 will restart with the new version of software.
9. Check if the AnB modules also need updating. See “Updating the AnB Modules”.

Updating the AnB Modules

1. From the Select Task screen tap Settings.
2. Now Tap System Info; the AnB modules should be listed in a table.
3. Compare each AnB firmware version with the “Latest AnB Firmware” field in the System Information panel. Outdated AnB modules will also have a yellow warning in the Firmware column stating as such.
4. Tap the AnB module to you want to update.
5. Select Update Firmware.
6. Click ‘I Understand’ on the warning screen.
7. Wait for Update to complete. Do not turn off the T-Box™ or close the T-Box™ UI during the update.
8. If you get an Error at the end of the update Restart the T-Box™2.
9. Check version Numbers of AnB module.
10. Repeat steps 3 - 7 for another AnB module.

SPECIFICATION – GENERAL

Input Voltage	Equivalent Torque	Accuracy	Calibration Uncertainty*
@0.5 mV	5% of capacity	±0.1% of reading	±0.16%
@1.0 mV	10% of capacity	±0.05% of reading	±0.097%
@2.0 mV	20% of capacity	±0.05% of reading	±0.085%
@3.0 to 11.0 mV	30% to 110% of capacity	±0.05% of reading	±0.070% to ±0.053%

*Using a coverage factor of k=2, to give a confidence level of approximately 95%.

Resolution:	5 active digits for all Norbar transducers.
Display:	10.1" Colour display with touch screen. With update rate of twenty times per second (20Hz).
Torque Unit Conversions:	To 'BS 350:2004 Conversion factors for units'.
Zero Suppression:	None.
Time/Date Compliance:	To year 2099.
Units of Measurement:	N·m, dN·m, cN·m, kgf·m, kgf·cm, gf·m, gf·cm, lbf·ft, ft·lb, lbf·in, in·lb, ozf·in, in·oz
Frequency Response:	8 th Order Butterworth low pass filter with a -3dB point settable from 100 to 2500 Hz.
Angle Display:	Channel A & B quadrature inputs give 4 unique logic states per pulse. Angle display shown to 2 decimal places as examples:

Transducer Pulses per Revolution	Transducer Pulses per Degree	Quadrature Logic States per Degree	T-Box™ 2 Resolution
360	1	0.25	0.25
720	2	0.125	0.13
1440	4	0.0625	0.06

Operating Temperature Range:	+5°C to +40°C.
Storage Temperature Range:	-20°C to +70°C.
Maximum Operating Humidity:	85% Relative Humidity @30°C.
Power Supply Adapter:	100 to 240 V A.C. at 50 - 60 Hz input. 15 V, 3.36 A D.C. output (centre positive).
Power Consumption:	< 20 W with no external USB devices connected (External USB devices must not exceed 30 W)
Power Cable:	114 cm (44 ins) long.
Weight (T-Box™ 2 and Stand):	5.2 kg.
Dimensions:	254 mm high x 300 mm wide x 200 mm deep.
Case Materials / Finish:	Anodised Aluminium and ABS.
Environment :	Indoor use within a light industrial environment.
Electromagnetic Compatibility: (EMC) Directive	In conformance with EN 61326:2013.
Low Voltage Directive:	In conformance with EN 61010-1:2010. To environmental conditions Pollution Degree 2 & Installation Category (Over voltage Category) II.

NOTE: Due to continuous improvement all specifications are subject to change without prior notice.

SPECIFICATION – TRANSDUCER INTERFACE

Smart Transducers

Norbar 'SMART' transducers store the calibration data; they are available in 4 types:

Suffix	'SMART' Transducer Description		
	Integral Angle Encoder?	Calibration	mV/V Figure Supplied
XXXXX.IND	No	mV/V	Yes
XXXXX.INDA	Yes	mV/V	Yes
XXXXX.LOG	No	With a T-Box™ 2 in torque units	Yes
XXXXX.LOGA	Yes	With a T-Box™ 2 in torque units	Yes

For additional accuracy SMART transducers can be factory programmed with a second-degree polynomial, so any slight errors can be reduced. These transducers are identified as 'linearised' on the transducer information screen.

Pin Connections

Pin No	Function
1	+ve transducer excitation.
2	-ve transducer excitation.
3	+ve transducer signal.
4	-ve transducer signal.
5	Digital 0 volts.
6	Digital +5 volts for transducer selected, digital 0 volts when not selected.
7	Rotary transducer angle input (Channel A).
8	Rotary transducer angle input (Channel B).
9	Serial clock (SMART memory).
10	Serial data (SMART memory).

Connector Type

10-way 'Push-Pull' style panel socket.

SPECIFICATION - ANCILLARIES

The Ancillaries connector contains inputs and outputs for connection to external equipment.

Pin Connections

Pin No	Function
1	Digital +5 V (maximum current 5 mA).
2	External PRINT / RESET Input (Active High).
3	Low Limit Torque Output.
4	Pass Limit Torque Output.
5	High Limit Torque Output.
6	Low Limit Angle Output.
7	Pass Limit Angle Output.
8	High Limit Angle Output.
9	Digital 0 V.
10	Tool Stop Output.
11	Analogue Output.
12	Analogue Output 2.5 V.
13	Analogue Output 0 V reference (Do not connect to a noisy electrical ground).
14	External Snug Trigger Input.
15	Not Used.

External Print / Reset Input

Pins 1 & 2 are intended for use as an EXTERNAL PRINT / RESET:-



The switch must remain active for at least 200 mS. Screened cable is recommended.

Limit Outputs

Pins 3, 4, 5, 6, 7 & 8 are buffered logic outputs intended for Go/No Go control of external equipment. The limit outputs are referenced to Pin 9 (Digital 0 V). All limit outputs are active HIGH and are updated every 10 mS

The limit outputs change exactly with increasing torque and at 0.5% of transducer capacity below the limit with decreasing torque. This eliminates the logic lines oscillating.

The Limit output current is, High = -0.8 mA, Low = 16 mA (not for direct control of relays).

Tool Stop Output

Tool Stop is used to provide a stop signal for an external pneumatic, hydraulic or electric tool. When the measured torque goes above the Tool Stop value (set in the Target Setup) this pin goes HIGH (5 V) with reference to pin 9.

Analogue Output

The analogue output is designed for connection to a control system. The DAC has an update time of 1 kHz. The calibration of the analogue output is factory set and not adjustable.

The analogue output is PIN 11.

If the output is measured against PIN 12 (2.5 V) the signal will swing positive for clockwise torque and negative for counter-clockwise torque.

If the output is measured against PIN 13 (0 V) the signal will always be positive, with zero torque around 2.5 V.

NOTE: Some transducers (Norbar Annular type) will give a negative output change for a positive torque. This is because they are designed to measure reaction torque.

External Snug Trigger Input

The external snug trigger is used to start the angle measurement; for external operation ensure the Target Setup has "Internal Snug Torque Trigger" UN-TICKED. Use logic 5 V (HIGH) input with reference to pin 9 (0 V).

Connector Type

15-way female 'D' type connector.

SPECIFICATION - SERIAL PORT

The serial port is for sending data to a PC.

See Settings Screen >> Serial Ports.

Pin Connections

The port is configured as DTE (Data Terminal Equipment) and conforms to RS-232-C specifications. The transmitted data voltage levels are between +5 to +9 volts and -5 to -9 volts.

Pin No	Function
1	Not Connected.
2	Received data (to T-Box™ 2).
3	Transmitted data (from T-Box™ 2).
4	Not Connected.
5	Signal ground 0 V.
6	Not Connected.
7	Not Connected.
8	CTS (clear to send).
9	Not Connected.

Data Output Example

Code: DP=Decimal Point. CR=Carriage Return. LF=Line Feed. SP=Space.

T-Box™ 2 with the serial port set to the factory defaults. Reading 1068.4 lbf-ft (clockwise).

1	0	6	8	DP	4	SP	l	b	f	DP	f	t	CR	LF
---	---	---	---	----	---	----	---	---	---	----	---	---	----	----

NOTE: The maximum number of characters per line = 24.

Connector Type

9-way male 'D' type connector.

Connecting Lead

A 9-way female to 9-way female null modem connecting lead is required for connection to a PC with a 9-way male connector.

SPECIFICATION - USB

The T-Box™ 2 has two Universal Serial Bus (USB) connectors.

These connectors can fully support the use of a Keyboard and mouse (not supplied).

NOTE: It is not advised to connect USB devices that may draw high current to the T-Box™ 2.

MAINTENANCE

T-Box™ 2 Calibration

Your T-Box™ 2 has been supplied with a certificate of calibration. To maintain the specified accuracy, it is recommended that the T-Box™ 2 is recalibrated at least once per year. Re-calibration should be carried out at Norbar or by a Norbar approved agent, where all the facilities to ensure the instrument is functioning at maximum accuracy are available.

IMPORTANT: DO NOT REMOVE BACK PANEL OR CASE; THERE ARE NO CALIBRATION SETTINGS INSIDE.

Transducer Calibration

To maintain the specified accuracy, it is recommended that transducers are recalibrated at least once per year. Re-calibration and repair should be carried out at Norbar or by a Norbar approved agent.

Repair

Repair should be carried out at Norbar or by a Norbar approved agent, where all the facilities to ensure the instrument is functioning at maximum accuracy are available.

Do not remove the T-Box™ 2 case; there are no parts for operator repair inside.

Cleaning

Do not use abrasives or solvent-based cleaners.

Product Disposal



This symbol on the product indicates that it must not be disposed of in the general waste.

Please dispose of according to your local recycling laws and regulations.

Contact your distributor or see the Norbar web site (www.norbar.com) for further recycling information.

Battery Disposal

This product contains 1 Battery. Only dispose of the battery at end of product life. Batteries contain substances that can have a negative effect on the environment and human health.

The crossed-out wheeled bin means that batteries must NOT be disposed of in the general waste.

All batteries must be disposed of at a local waste battery collection point.

The battery does NOT contain mercury (Hg), cadmium (Cd) or lead (Pb). If the battery substances exceed the legal limits the battery would be marked with Pb, Cd or Hg.

TROUBLESHOOTING

Tips are located within the operator's manual to help with troubleshooting.

Common problems are listed below:

Problem	Likely Solutions
T-Box™ 2 shuts down unexpectedly.	Check there are no external USB devices connected that drew high current.
T-Box™ 2 fails to start.	Check power supply connections.
T-Box™ 2 cannot find a transducer.	Check that a Smart transducer is connected to one of the transducer ports.

Serial Port Problem	Likely Solutions
Serial data output is not communicating with other equipment.	<ol style="list-style-type: none"> 1. Check that the baud rate is set to the same as the receiving equipment. 2. Check that all serial port parameters (Data bits, Stop bits, Parity & Flow Control) on the T-Box™ 2 and the receiving equipment match. 3. Check the correct null modem serial lead is being used. 4. Check if receiving equipment requires 'First Character' or limits removed or units removed.
Serial output is being overwritten.	Line feed required. In 'Serial Port Setup' change 'Output Line Feed' to 'Enable'.
Cannot communicate with Norbar 'Torque Wrench Calibration Software' (Part No 37705.XXX).	The software will not accept limit characters LO / OK / HI. In 'Serial Port Setup' change 'Output Limits' to 'Disable'.
Serial data too slow.	In the 'Serial Port Setup' change 'Output Rate' to a higher value.

NOTE: For more complex faults please contact Norbar distributor / manufacturer.

EXAMPLE SETUPS

Example 1 - Click Wrench Torque Measurement

For this example, we are going to check a Click Torque wrench set to 50 N·m with an accuracy of +3% / -3%

1. We will go through Transducer connection, T-Box™ 2 power up, mode selection, simple target creation, doing a measurement and finally saving the result. Although this is a simple example it will give you a good understanding of the moving around the menu structure.

Connection and Power up

2. Connect correct Transducer to the T-Box™ 2.
3. Connect the T-Box™ 2 to the power supply.
4. Connect the power supply to the mains.
5. On the T-Box™ 2's front panel press the power button.

Setting Up the T-Box™ 2

6. From the Select Task Screen tap MEASURE (you will see the Select AnB Screen).
7. Tap the Transducer icon to select the AnB port that the transducer is connected to (You will see the Measure Screen).

Setting the Measure Mode

8. Tap just below MODE (you will see the Select Mode Screen).
9. Tap CLICK then Scroll down. Under AUTO RESET tap Disabled.
10. Press SET (You will see the Measure Screen).

Creating a New Target

11. Tap just below TARGET (you will see the Target Select Screen).
12. If New is available on the screen tap it (you will see the Targets New Screen).
If New is not available tap on the currently selected target (this will de-select it) then tap New.
13. Tap SELECT UNITS and Press N·m
14. Tap TORQUE ONLY (you should now see the Targets New Screen).
15. Tap just under TARGET IDENTITY and give your Target a name, then tap the Tick (you will be back to the Targets New Screen).
16. Under Direction tap CW.
17. Tap # of Readings then enter 1 and tap the Tick (you should now see the Targets New Screen).
18. Under TORQUE TARGET tap Torque Target then enter 50 and tap the Tick.
19. Tap Lower Limit, select Percentage and enter 3 tap the Tick.
20. Do the same for Upper Limit.
21. You should now be on the Targets New Screen having set up a 50 N·m Torque only target with +3% / -3% Limits and CW only.
22. When you have checked that, tap SAVE (You should now be on the Targets Select Screen).
23. On the Targets Select Screen tap your target (it should have a white background when selected) and tap SET TARGET.

Doing a Measurement

24. You will now be back at the Measure Screen and you are almost ready to use your target
25. Check the Measure screen shows that MODE is CLICK MANUAL RESET and TARGET is 50 N·m +3% / -3%
26. Tap ZERO TRANSDUCER.
27. The reading on the screen should be 0.00 N·m
28. You can now capture a reading.
29. Once you have captured a reading you should see the result on the screen (colour will depend on the results: red = too high, yellow = too low and green is a pass.
30. To Save the result tap the Save Icon.

Example 2 – Copy Readings Folder to Memory Stick

In this example, we are going to copy your Readings Folder to a memory stick.

Finding your Readings Folder

1. From the Selection Screen tap File Browser.
2. Tap the Drive Icon.
3. Tap Main Storage.
4. Tap home.
5. Double tap 'user'.
6. Scroll to 'Readings'.
7. Single tap 'Readings'.

Copy Results

8. Tap Copy.

Navigating to the Memory Stick

9. Tap the Drive Icon.
10. Tap 'Removable Media'.
11. Double Tap the folder icon with the name of your memory stick.

Pasting Results

12. Tap Paste.
13. Wait for Files to copy.
14. Press 'Eject'.
15. Wait for prompt saying the stick is safe to remove.
16. Remove Memory Stick from T-Box™ 2.

Example 3 - Hydraulic Wrench calibration

For this example, we're going to test a hydraulic/pneumatic wrench using a pressure transducer and a torque transducer attached to the AnB modules. Our goal is to measure the torque produced by the tool at specific pressure levels.

1. Set up a new Targets file with a series of pressure targets corresponding to the pressure levels of interest. You likely have at least a few levels of interest across the capacity range of the tool, but if you are interested in more data points, just add more targets. Your targets should use a very small (or even 0%) lower tolerance, to ensure the readings are captured as close to the target point as possible.
2. Enter the Targets screen settings and change the targets type to "Linked".
3. Return to the target list on the Targets screen and use the Up/Down buttons to arrange the targets by pressure in ascending order (the list should start with the lowest pressure and end at the highest).
4. (Optional) Repeat steps 1-3 to make another Linked Targets file containing a series of increasing torque targets that correspond to each of the pressure targets; these represent the anticipated torque output of the tool at each given pressure target. It may be useful to have the pressure and torque targets files opened side-by-side during this step.
5. Open a Measurement screen for the AnB module connected to the pressure transducer. Go to Mode settings and change the mode to Hydraulic. Enable Auto Reset, Progressive Reset and Broadcast Capture Trigger, then press Set to set the mode. This prepares the AnB module to sweep through a progressive series of linked targets and trigger captures of corresponding readings on the other AnB module.
6. On the Measurement screen, open the Targets screen and set the AnB module's target to the first target of the pressure targets file. You may need to go into Targets screen settings and open the targets file from there.
7. Ensure the Save button is toggled on. With the mode configured and initial target set, the pressure AnB is ready to sweep through the list of linked pressure targets.
8. Open a second Measurement screen for the AnB module connected to the torque transducer.
9. Go to Mode settings on the torque AnB and change the mode to Hydraulic. Ensure Auto Reset is enabled. Ensure Progressive Reset is disabled and Broadcast Capture Trigger is disabled.
11. After setting the torque AnB mode, you should have two Measurement screens side-by-side, one for pressure, one for torque. Begin sweeping through the pressure range; you should see the AnB module smoothly capture pressure readings the moment the target pass conditions are met. You should see corresponding torque readings simultaneously captured on the torque AnB. If you followed the optional steps, you should also see the torque AnB step through each torque target in tandem with every pressure reading.

GLOSSARY OF TERMS

Word or Term	Meaning
A.C.	Alternating current.
Active From	Value from which the memory modes operate.
ADC	Analogue to Digital Converter.
AnB	Analogue Board (a module which reads transducers).
Auto Reset Hold Time	The length of time a reading is displayed until automatically reset.
CAL	Calibration.
Capacity	Transducer full scale.
Custom Calibration	A calibration that is not to ISO 6789.
D.C.	Direct current.
First Peak Sensitivity	The amount by which the reading must fall below the peak for the display to be held.
Frequency Response	Frequency value below which signals are passed.
Hz	Hertz, unit of frequency.
ISO 6789	Hand torque tool ISO Standard. Has been updated from ISO 6789:2003 to ISO6789:2017, which is now in 2 parts.
ISO 6789-1:2017	Part 1 of the latest version of the Hand torque tool ISO standard. Specifically refers to design conformance.
ISO 6789-2:2017	Part 2 of the latest version of the Hand torque tool ISO standard. Specifically refers to calibration and measurement uncertainty.
GB	Gigabyte – Amount of memory.
Lemo	Reference for manufacturer of connector.
mA (milliamp)	One thousandth of an amp (0.001A).
MB (Megabyte)	Amount of digital memory.
mS (millisecond)	One thousandth of a second (0.001 second).
mV (millivolt)	One thousandth of a volt (0.001 volt).
mV/V (millivolt per volt)	Ratio of millivolt output to voltage input.
NON-SMART	Standard mV/V transducer (NON-INTELLIGENT).
PC	Personal Computer.
Pulse Count	The number of torque pulses applied in Pulse mode or Screwdriver mode.
Sample Rate	Number of measurement samples taken in 1 second.
SMART	Serial Memory Automatic Recognition Transducer (INTELLIGENT).
SMART Transducer	A transducer that holds its own calibration data (INTELLIGENT).
Snug Torque	Torque value to start measuring angle.
Target	Torque or Angle value required. Each Target has an Upper Limit and a Lower Limit.
TDMS	Torque Data Management System – Software included for PC use.
Tool	A reference to the tool being calibrated or used. E.G.: Torque wrenches, PneuTorques, Electric tools, Torque screwdrivers, etc.
USB	Universal Serial Bus.
V	Volts.
Tap	A quick press with your finger on the screen.
Double Tap	2 quick presses with your finger on the screen.
Scroll	Press on the screen and move your finger up or down.
TD	Transducer.

**NORBAR TORQUE TOOLS LTD**

Wildmere Road, Banbury
Oxfordshire, OX16 3JU
UNITED KINGDOM
Tel + 44 (0)1295 270333
Email enquiry@norbar.com

**NORBAR TORQUE TOOLS PTE LTD**

194 Pandan Loop
#07-20 Pantech Business Hub
SINGAPORE 128383
Tel + 65 6841 1371
Email enquires@norbar.sg

**NORBAR TORQUE TOOLS**

45-47 Raglan Avenue, Edwardstown
SA 5039
AUSTRALIA
Tel + 61 (0)8 8292 9777
Email norbar@norbar.com.au

**NORBAR TORQUE TOOLS (SHANGHAI) LTD**

91 Building- 7F, No. 1122, Qinzhou North Road
Xuhui District, Shanghai
CHINA 201103
Tel + 86 21 6145 0368
Email sales@norbar.com.cn

**NORBAR TORQUE TOOLS INC**

36400 Biltmore Place, Willoughby
Ohio, 44094
USA
Tel + 1 866 667 2279
Email inquiry@norbar.us

**NORBAR TORQUE TOOLS INDIA PVT. LTD**

Plot No A-168, Khairne Industrial Area
Thane Belapur Road, Mahape
Navi Mumbai – 400 709
INDIA
Tel + 91 22 2778 8480
Email enquiry@norbar.in

www.norbar.com